



Wasch- und Nachspülsysteme

Seite 278



Diverses und Luftfallen

Seite 280

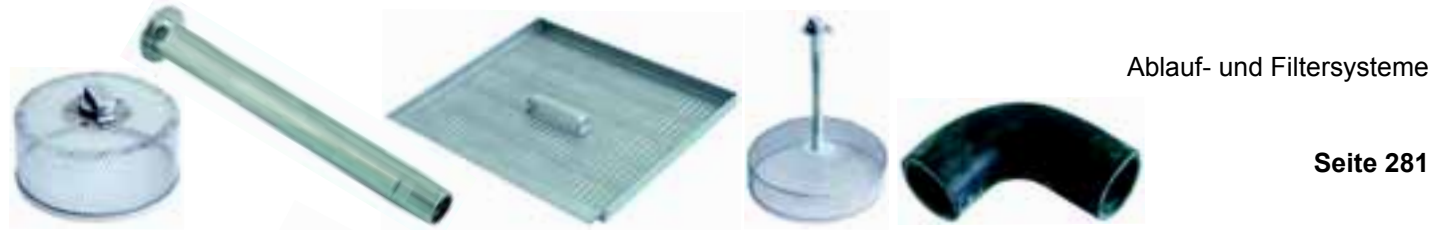

Ablauf- und Filtersysteme

Seite 281



Tür- und Haubenmechanik

Seite 283



Elektrokomponenten

Seite 284



Dosiertchnik

Seite 286



Heizkörper und Boiler

Seite 287



Pumpen und Ersatzteile

Seite 288

M Wasch- und Nachspülssysteme

Passend für Mach



Abb.	Best.-Nr.	Beschreibung	Geräte-Typ	Vergl.-Nr.
1	504047	Drehteller		1591
2	504075	Wascharm	MB520	2015
3	504018	Dichtung	MB630	1159
4	504048	Waschdüsenkappe		1597
5	504049	Waschdüsenhalter		1599



Abb.	Best.-Nr.	Beschreibung	Geräte-Typ	Vergl.-Nr.
1	504074	Nachspülarm	MB520	2013
2	504092	Einschraubwinkel		2267
3	504081	Dichtung		2189
4	504050	Mutter/ CNSM20x1,5	MB630	1647
5	101248	Doppelkonus, 12mm		1071
6	504007	Überwurfmutter		1069
7	504093	Nachspülarm		2269



Abb.	Best.-Nr.	Beschreib.	Geräte-Typ	Vgl.-Nr.
1	504065	Wasch- und Nachspülarm	GL220, MB235LI, MB510E, MB510ER, MB520, MB520K, MB530, MB530K, MB535	4447, 1931
2	504040	Wasch- und Nachspülarm	GL250, MB240LI, MGL40, MB630, MB920E, MB920ER, MB930, MB930K	4449, 1483
3	504198	Nachspülarm	MB235LI, MB240LI	4275



Abb.	Best.-Nr.	Beschreib.	Geräte-Typ	Vgl.-Nr.
1	504010	Wasch- und Nachspülarm	MS350	4451, 1077
2	504025	Wasch- und Nachspülarm	MS450, MS450E, MS700, MS900, MS1100, MS1300	4453, 1249



Abb.	Best.-Nr.	Beschreib.	Geräte-Typ	Vgl.-Nr.
1	504166	Wascharmkreuz	MLP60, MLP60E, MLP70, MLP80, MLP140	4001
2	504151	Wascharm, 240mm		3855
3	504167	Wascharm, 270mm		4003
4	504145	Wascharm, 300mm	MLP60, MLP60E, MLP140, MLP70,	3825
5	504152	Nachspülarm	MLP80, MLP140	3857
6	504168	Nachspülarm		4005



Abb.	Best.-Nr.	Beschreibung	Geräte-Typ	Vergl.-Nr.
1	504205	Nachspüldüse		4327
2	504204	Nachspüldüsenclip	Alle Typen	4325
3	504203	Endkappe		4323

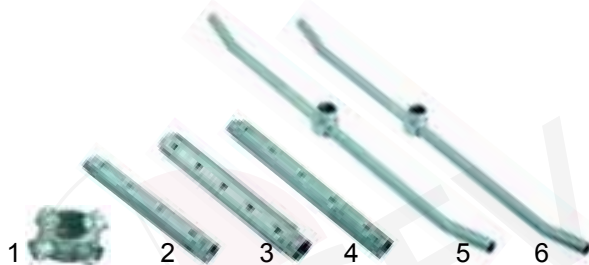

Abb.	Best.-Nr.	Beschreibung	Ger.-Typ	Vergl.-Nr.
1	504015	Nachspüldüse		1093
2	504100	Dichtung		2387
3	504013	Augenschrauben, O-Ring	Alle Typen	1089, 1091
4	504079	Buchse	bis 1.05.2000	2171
5	504107	O-Ring		2429
6	504080	Endkappe		2173

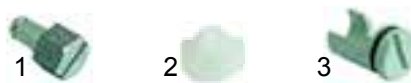

Abb.	Best.-Nr.	Beschreibung	Geräte-Typ	Vergl.-Nr.
1	504066	Halteblech	GL220, GL250	1933
2	504006	Rändelschraube	MB_	1053
3	504073	Scheibe	MS_	2003
4	504072	Wascharmlager	MGL_	2001



Abb.	Best.-Nr.	Beschreibung	Geräte-Typ	Vergl.-Nr.
1	504181	Blockierschraube		4081
2	504180	Buchse-Nachspülarm		4079
3	504179	Mutter (Lager)	MLP60, MLP60E, MLP70, MLP80,	4077
4	504177	Buchse	MLP140	4073
5	504178	Wascharmlager		4075



Abb.	Best.-Nr.	Beschreibung	Geräte-Typ	Vergl.-Nr.
1	504194	Wascharmstift	GL220, GL250,	4249
2	504109	Wascharmverlängerung	MB235LI, MB240LI, MB510E, MB510ER,	2435
3	504069	Wascharmhalter/ unten	MB530, MB530K, MB535, MB920E, MB920ER, MB930, MB930K	1959, 2417
4	504041	Dichtung		1485



Abb.	Best.-Nr.	Beschreibung	Geräte-Typ	Vergl.-Nr.
1	504194	Wascharmstift		4249
2	504136	Wascharmhalter/ unten	MGL40	2945
3	504041	Dichtung		1485



Abb.	Best.-Nr.	Beschreibung	Geräte-Typ	Vergl.-Nr.
1	504089	Wascharmhalter/ oben	GL250, MB510E, MB510ER, MB630,	2501, 2241
2	504009	Wascharmstift	MB520E, MB920ER,	1075
3	504090	O-Ring	MB930, MB930K, MGL40	2243



Abb.	Best.-Nr.	Beschreibung	Geräte-Typ	Ver.-Nr.
1	504019	Mutter		1165
2	504020	Dichtung	MB235LI	1167
3	504197	Nachspülarmhalter/ oben	MB240LI	4273
4	504009	Nachspülarmstift		1075
5	504072	Nachspülarmlager		2001



Abb.	B.-Nr.	Beschreibung	Geräte-Typ	Vgl.-Nr.
1	504096	Wascharmhalter/oben, unten	MS350	2333
2	504024	Wascharmhalter/oben, unten	MS450, MS450E	1247
3	504053	Wascharmhalter/oben, unten	MS700, MS700E	1687



Abb.	Best.-Nr.	Beschreibung	Geräte-Typ	Vergl.-Nr.
1	504058	Wascharmhalter/ oben, unten	MS900/ MS1100	1761
2	504035	Wascharmhalter/ oben, unten	MS1300	1395



Abb.	Best.-Nr.	Beschreibung	Geräte-Typ	Vergl.-Nr.
1	504097	Schlauchverschraubung		2335
2	504098	Verteiler		2337
3	504122	Dichtung	MS350	2557
4	504095	Verteilerdeckel		2331
5	504009	Wascharmstift/ oben		1075
6	504121	Wascharmstift/ unten		2549

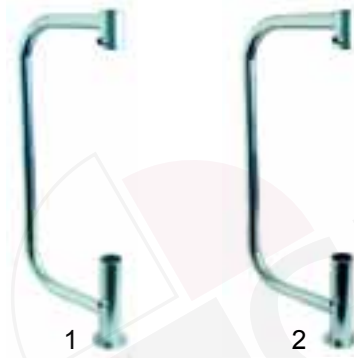

Abb.	Best.-Nr.	Beschreibung	Geräte-Typ	Vergl.-Nr.
1	504009	Wascharmstift	MS450, MS450E,	1075
2	101248	Doppelkonus	MS700, MS700E,	1071
3	504007	Überwurfmutter	MS900, MS1100,	1069
4	504018	Dichtung	MS1300	1159

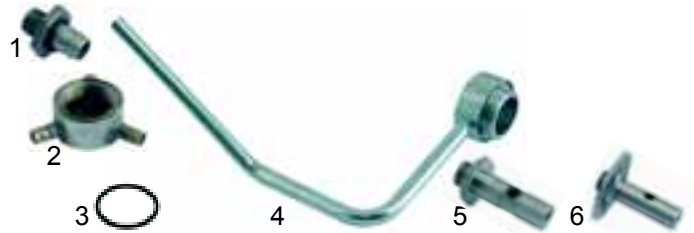

Abb.	Best.-Nr.	Beschreibung	Geräte-Typ	Vergl.-Nr.
1	504143	Wascharmhalter/ unten	MLP60,	3821
2	504018	Dichtung	MLP60E,	1159
3	504176	Wascharmstift	MLP70,	4071
4	504175	Lochscheibe	MLP80,	4069
5	504142	Wascharmhalter/ oben	MLP140	3819

Diverses



Abb.	Best.-Nr.	Beschreibung	Geräte-Typ	Vergl.-Nr.
1	504206	Y-Stück, 3-fach		4329
2	504202	Kreuz-Stück, 4-fach		4321
3	504077	T-Stück, CNS, 12mm, ohne Doppelkonus	MLP60, MLP60E	2021
4	101248	Doppelkonus, 12mm		1071
5	504156	Schlauchanschluss, 3/8"		3887
6	504141	Schlauchanschluss, 3/8"		3815



Abb.	Best.-Nr.	Beschreibung	Geräte-Typ	Vergl.-Nr.
1	504110	Rohrschelle		2457, 2909
2	504132	Magnetventilanschluss		2935
3	504133	T-Magnetventilanschluss, 1 1/4"	MG240	2937
4	504134	Überwurfmutter, 1 1/4"		2939



Abb.	Best.-Nr.	Beschreibung	Geräte-Typ	Vergl.-Nr.
1	504170	Verteiler, 4-Wege	MLP70/MLP80	4009
2	504188	Verteiler, 6-Wege	MLP__	4147
3	504112	Pressostat-Halter	GL220, MB535	2463
4	504140	Rücksaugverhinderer		3003



Abb.	Best.-Nr.	Beschreibung	Geräte-Typ	Vergl.-Nr.
1	504162	Kugelhahn	MLP60,	3943
2	504183	Gewindestange	MLP60E,	4087
3	504169	Verlängerung	MLP70,	4007
4	504187	Hebel	MLP80, MLP140	4131



Abb.	Best.-Nr.	Beschreibung	Geräte-Typ	Vergl.-Nr.
1	504045	Salzbehälter		1545
2	504017	Nachspülmittelbehälter		1117
3	504046	Enthärter		1555



Abb.	Best.-Nr.	Beschreibung	Geräte-Typ	Vergl.-Nr.
1	504125	Wanneneinlauf		2819
2	504082	Schlauchanschluss Boiler		2195
3	504078	Endkappe Boiler (CMS) M20x15		2023
4	504081	Dichtung 20mm		2189

Luftfallen



Abb.	Best.-Nr.	Beschreibung	Geräte-Typ	Vergl.-Nr.
1	504062	Luftfalle	MS700E	2917, 1885
2	504116	Luftfalle	MB235LI/ MB240LI, MB510E/ MB510ER	2507
3	504103	Luftfalle	MB920E/ MB920ER	2415
4	504028	Luftfalle	MS450, MS450E, MS700	1273
5	504193	Luftfalle	MS350	4247
6	504020	Dichtung		1167
7	503042	Mutter, 3/8"		1165



Abb.	Best.-Nr.	Beschreib.	Geräte-Typ	Vgl.-Nr.
1	504207	Luftfalle	GL220, MB520, MB520K,	4343
2	504209	Dichtung, M10	MB530, MB530K, MB535,	4347
3	504208	Mutter, M10	MB900, MS1100, MS1300,	4345
4	504088	Luftfalle	GL250, MB630, MB930, MB930K	2239



Abb.	Best.-Nr.	Beschreibung	Geräte-Typ	Vergl.-Nr.
1	504212	Filter	MLP60, MLP60E,	3981
2	504213	Filterhalter	MLP70, MLP80, MLP140	4022, 4027

Ablauf- und Filtersysteme

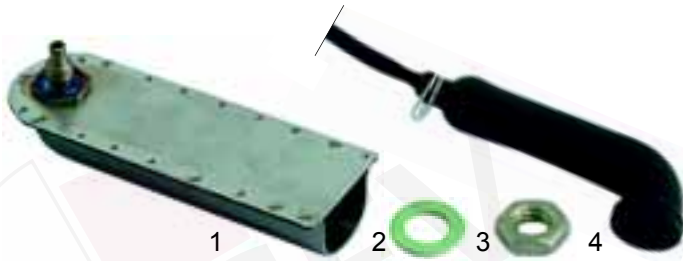
Filter

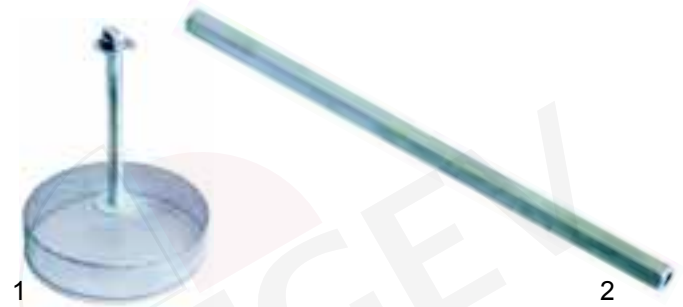

Abb.	Best.-Nr.	Beschreibung	Geräte-Typ	Vergl.-Nr.
1	504043	Filter	GL220, MB520,	1515
2	504070	Filterhalter, 90mm	MB520K, MB530, MB530K, MB535	1961
3	504106	Filter	MB235LI, MB240LI,	2925
4	504111	Filterhalter, 44mm	MB510E, MB510ER, MB920E, MB920ER	2923



Abb.	Best.-Nr.	Beschreibung	Geräte-Typ	Vergl.-Nr.
1	504102	Flachfilter	MS700, MS700E	2405
2	504101	Mittelsteg		2403
3	504210	Flachfilter	MS900, MS1100	4411
4	504061	Mittelsteg		1847



Abb.	Best.-Nr.	Beschreibung	Geräte-Typ	Vergl.-Nr.
1	504083	Filter	GL250, MB630,	2217
2	504084	Filterführung	MB930, M930K	2219
3	504131	Filter/ außen	MGL40	2925
4	504130	Filter/ innen		2923

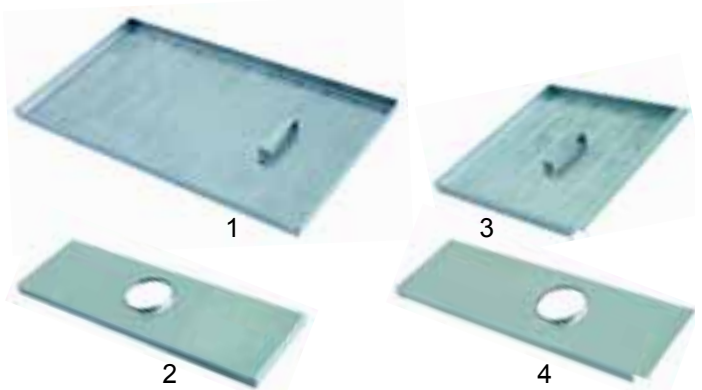

Abb.	Best.-Nr.	Beschreibung	Geräte-Typ	Vergl.-Nr.
1	504211	Flachfilter	MS1300	4419
2	504060	Mittelsteg		1817
3	504149	Flachfilter/ vorne	MLP60, MLP60E	3851
4	504150	Flachfilter/ hinten		3853



Abb.	Best.-Nr.	Beschreibung	Geräte-Typ	Vergl.-Nr.
1	504126	Filter/Laugenpumpe	MB__	2833
2	504005	Filter	MS350, MS450,	1051
3	504039	Filterhalter	MS450E, MS700, MS700E, MS900, MS1100, MS1300	1435

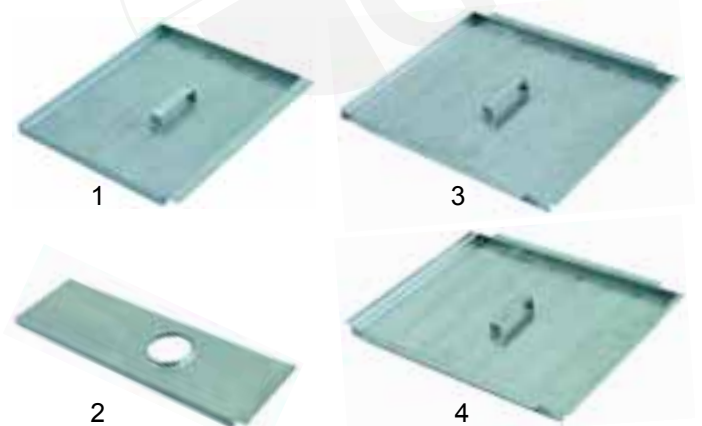

Abb.	Best.-Nr.	Beschreibung	Geräte-Typ	Vergl.-Nr.
1	504164	Flachfilter/ vorne	MLP70, MLP80	3997
2	504165	Flachfilter/ hinten		3999
3	504189	Flachfilter/ vorne	MLP140	4161
4	504190	Flachfilter/ hinten		4163

Überlaufrohre



Abb.	Best.-Nr.	Beschreibung	Geräte-Typ	Vergl.-Nr.
1	504064	Überlaufrohr	GL220, MB520, MB520K, MB530, MB530K, MB535, MB235LI, MB240LI, MB510E, MB510ER, MB920E, MB920ER	1913, 1517
2	504051	Überlaufrohr	GL250, MB630, MB930, M930K, MS700, MS700E, MS900, MS1100, MS1300	1667, 2221, 1731

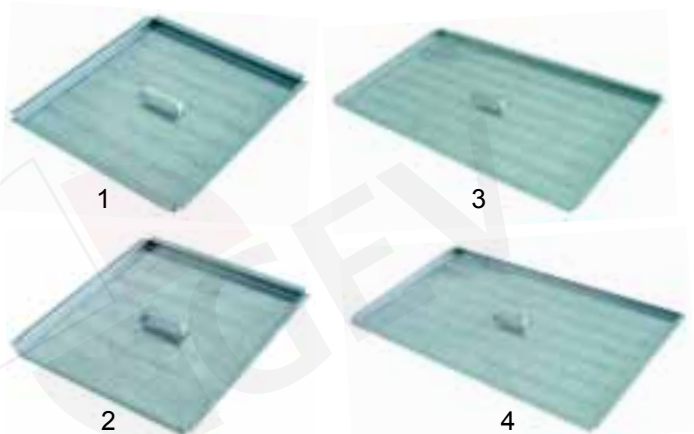

Abb.	Best.-Nr.	Beschreibung	Geräte-Typ	Vergl.-Nr.
1	504023	Überlaufrohr	MS450, MS450E	1233
2	504200	Überlaufrohr	MLP60, MLP60E	4287

Ablauf

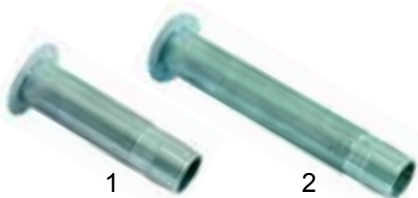

Abb.	Best.-Nr.	Beschreibung	Geräte-Typ	Vergl.-Nr.
1	530571	Ablaufschlauch 24/28	GL220, MB235LI, MB510E, MB510ER, MB520, MB520K, MB530, MB530K, MB535	2513
2	504059	Ablaufschlauch 28/28	GL250, MB240LI, MB630, MB920E, MB920ER, MB930, MB930K, MGL40, MS350, MS450, MS450E, MS700, MS700E, MS900, MS1100, MS1300	1777

Druck- und Saugschläuche



Abb.	Best.-Nr.	Beschreibung	Geräte-Typ	Vergl.-Nr.
1	504071	Druck- und Saugschlauch, 30x100mm	GL220, GL250, MB520, MB520K, MB530, MB530K, MB535, MB630	1963
2	504042	Druckschlauch, 30x45mm	MB235LI, MB210LI, MB510E, MB510ER	1487
3	504012	Druckschlauch, 40x46mm	MS350	1085
4	504027	Druckschlauch, 45x40	MS450, MS450E, M700, MS700E	1255
5	504036	Saug- und Druckschlauch, 45x60	MS700, MS700E, MS900, MS1100, MS1300	1401
6	504185	Druckschlauch, 50x125	MLP60, MLP60E, MLP70, MLP80, MLP140	4097



Abb.	Best.-Nr.	Beschreibung	Geräte-Typ	Vergl.-Nr.
1	504068	Saugschlauch, 30mm	GL250, MB235LI, MB240LI, MB510E, MB510ER, MB630, MB920E, MB920ER, MB930, MB930K	1937
2	504011	Saugschlauch, 45mm	MS350, MS450, MS450E, MS900,	1081
3	504037	Saugschlauch, 60mm	MS1100, MS1300, MLP60, MLP60E, MLP70, MLP80, MLP140	1405
4	504160	Saugschlauch, 60x125mm	MLP70, MLP140, MLP80	4085, 3927
5	504184	Verlängerung, CNS, 60mm		4089



Abb.	Best.-Nr.	Beschreibung	Geräte-Typ	Ver.-Nr.
1	504186	Schlauch/ Steigrohr, 40x155	MLP_	4099
2	504173	Schlauchüberlauf		4017

Türmechanik

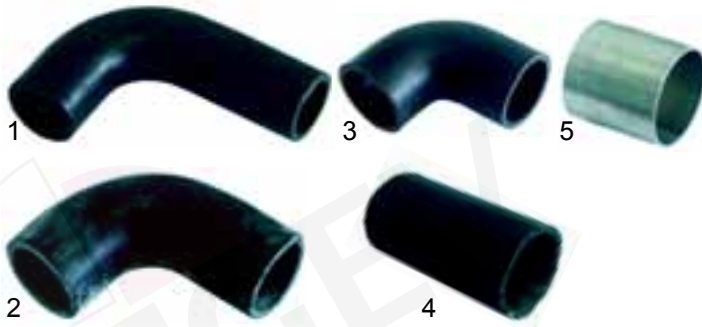

Abb.	Best.-Nr.	Beschreibung	Geräte-Typ	Ver.-Nr.
1	504000	Scharnier/ links	GL220, GL250, MB235LI, MB240LI, MB510E, MB510ER, MB520, MB520K, MB530, MB530K, MB535, MB630, MB920E, MB920ER,	1011
2	504002	Schenkelfeder	MB930, MB930K, MGL40, MS350, MS450, MS450E	1015
3	504004	Federspanner		1019
4	504003	Splint		1017



Abb.	Best.-Nr.	Beschreibung	Geräte-Typ	Ver.-Nr.
1	504063	Scharnier/ rechts	GL220, MB235LI, MB510E, MB510ER, MB520, MB520K, MB530, MB535	1895, 2499
2	504038	Scharnier/ rechts	MB630, MB930, MB240LI, MB920E, MB920ER	2233, 1475

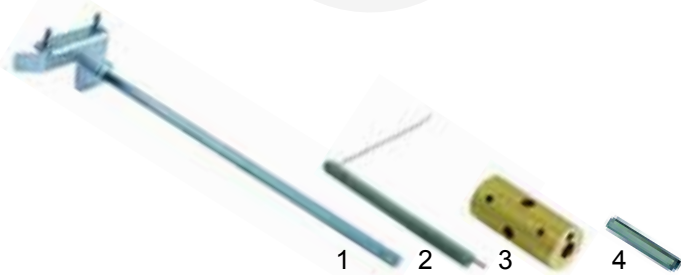

Abb.	Best.-Nr.	Beschreibung	Geräte-Typ	Ver.-Nr.
1	504001	Scharnier/ rechts	MS350	1013
2	504052	Scharnier/ rechts	MS450, MS450E, MS700, MS700E	1679



Abb.	Best.-Nr.	Beschreibung	Geräte-Typ	Ver.-Nr.
1	504002	Schenkelfeder	MLP60, MLP60E,	1015
2	504004	Federspanner	MLP70, MLP80, MLP140	1019
3	504003	Splint		1017
4	504192	Verlängerung	MLP140	4183
5	504153	Scharnier/ links	MLP60/ MLP60E	3859
6	504154	Scharnier/ rechts		3861



Abb.	Best.-Nr.	Beschreibung	Geräte-Typ	Ver.-Nr.
1	504171	Scharnier/ links	MLP70	4011
2	504159	Scharnier/ links	MLP80	3911
3	504191	Scharnier/ links	MLP140	4165
4	504052	Scharnier/ rechts	MLP70, MLP80, MLP140	1679

M

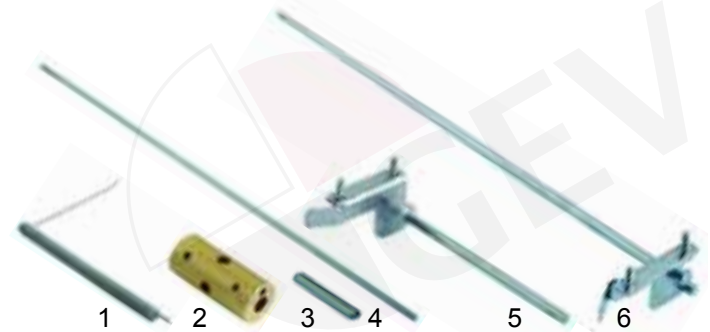
Haubenmechanik

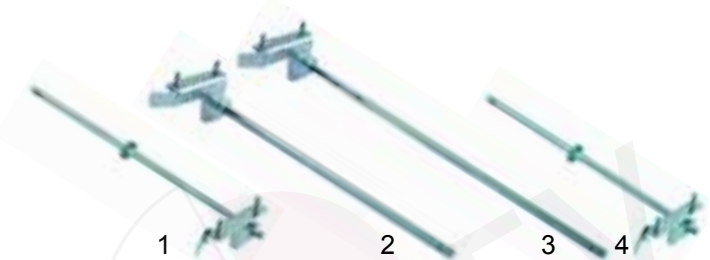

Abb.	Best.-Nr.	Beschreibung	Geräte-Typ	Vergl.-Nr.
1	504054	Hebelgelenk		1707
2	504055	Hebelmutter		1709
3	504056	Hebelschraube	MS900	1711
4	504031	Buchse	MS1100	1369
5	504032	Schelle	MS1300	1371
6	504029	Federhalter		1357
7	504030	Feder		1359
8	504033	Federspannung		1383



Abb.	Best.-Nr.	Beschreibung	Geräte-Typ	Ver.-Nr.
1	504124	Frontfolie	MS450, MS700E, MS450E, MS700	2805
2	504155	Frontfolie	MLP60	3863
3	504201	Frontfolie	MLP60E	4289



Abb.	Best.-Nr.	Beschreibung	Geräte-Typ	Ver.-Nr.
1	504172	Frontfolie	MLP70	4013
2	504147	Frontfolie	MLP80	3829
3	504146	Frontfolie	MLP140	3827

Schalter

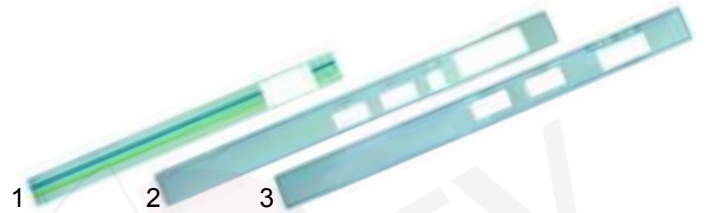

Abb.	B.-Nr.	Beschreib.	Geräte-Typ	Vgl.-Nr.
1	345116	Magnetschalter		2117
2	345553	Schalter 2-pol. Schließer	MB235LI, MB240LI, MB535, MLP60, MLP70, MLP80, MLP140	1955
3	345550	Taster 1-pol.	MB235LI, MB240LI, MB535, MS350, MS450E, MS700E, MS900, MS1100, MS1300	1547
4	345551	Schalter 2-pol. Wechsler	MB535	4349
5	345552	Schalter 3-pol.	MB520K, MB530K, MB930K	1999

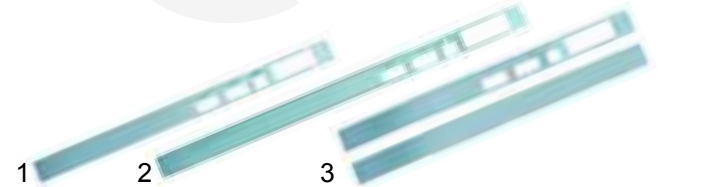

Abb.	B.-Nr.	Beschreib.	Geräte-Typ	Vgl.-Nr.
1	345556	Schalterkombination	MB510E, MB510ER, MB520, MB530, MB630, MB420E, MB920ER, MB930, MB930K, MGL40	2973 4381
2	345555	Schalterkombination	MS350, MS450E, MS700E, MS900, MS1100, MS1300	1995
3	345554	Schalterkombination	MS350, MLP60	1513



Abb.	Best.-Nr.	Beschreibung	Geräte-Typ	Vergl.-Nr.
1	359031	Signallampe grün		4313
2	359032	Signallampe gelb		4315



Pos.	Best.-Nr.	Beschreibung	Geräte-Typ	Vergl.-Nr.
1	504163	Griff	MPL___	3987

Elektrokomponenten

Frontfolien



Abb.	Best.-Nr.	Beschreib.	Geräte-Typ	Ver.-Nr.
1	504117	Frontfolie	MB510, MB510ER, MB520, MB530, GL220	2511
2	504119	Frontfolie	MB525, MB535	2543
3	504196	Frontfolie	MB235LI	4263
4	504199	Frontfolie	MB240LI	4283



Abb.	Best.-Nr.	Beschreibung	Geräte-Typ	Ver.-Nr.
1	504108	Frontfolie	MB630, MB920E, MB920ER, MB930	2431
2	504129	Frontfolie	MGL40	2921
3	504120	Frontfolie	MS350	2547
4	504123	Frontfolie	MS450, MS700, MS450E, MS700E	2803

Magnetventile

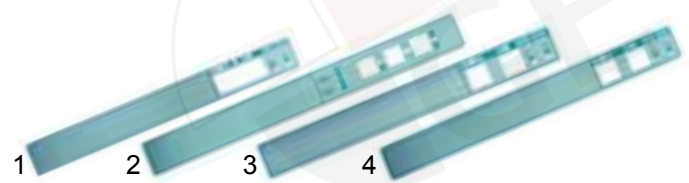

Abb.	Best.-Nr.	Beschreibung	Geräte-Typ	Vergl.-Nr.
1	370017	Einfach	MB235LI/ MB240LI	4267
2	370021	Zweifach	GL_/MB_/ MGL_/MS_/ MLP_	1537
3	370025	Dreifach	MB_K	1195

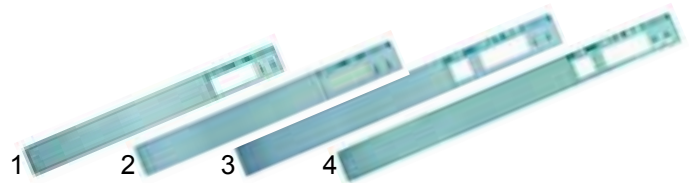

Pos.	Best.-Nr.	Beschreibung	Geräte-Typ	Vergl.-Nr.
1	504135	Magnetventil-Ablauf	MGL40	2941

Timer



Abb.	Best.-Nr.	Beschreibung	Geräte-Typ	Vergl.-Nr.
1	360201	Programm	MB_	4265
2	360072	Programm	GL220/ GL250	1967
3	360203	Regenerieren 20min.	MB520K, MB530K, MB530K	1553



Abb.	Best.-Nr.	Beschreibung	Geräte-Typ	Vergl.-Nr.
1	360207	Programm 120sec./180sec.	MS350,MS450, MS450E	1969
2	360202	Programm 240sec.	MS350	2359
3	360206	Programm 90sec./ 180sec.	MS700, MS700E	1971



Abb.	Best.-Nr.	Beschreibung	Geräte-Typ	Vergl.-Nr.
1	360205	Programm 75sec./120sec.	MS900	1973
2	360204	Programm 60sec./180sec.	MS1100, MS1300	1975
3	360208	Programm 180sec./360sec.	MLP60E	1855

Pressostate



Pos.	Best.-Nr.	Beschreibung	Geräte-Typ	Vergl.-Nr.
1	541001	Pressostat 35/17	GL220, MB235LI, MB240LI,MB510E,MB520 MB520K, MB350, MB530K, MB535, MB920E, MB920ER, MLP60, MLP60E, MLP70, MLP80,MLP140	2289 2273
2	541159	Pressostat 55/25	GL250, MB630, MB930, MB930K, MS350, MS450, MS450E	2277 2279 2281
3	541142	Pressostat 123/75	MS700, MS700E, MS900, MS1100, MS1300	2283 2285 2287
4	541161	Pressostat 205/95	MLP60, MLP60E, MLP70,MLP80,MLP140	4427

Entstörkondensator



Abb.	B.-Nr.	Beschreibung	Geräte-Typ	Ver.-Nr.
1	365044	0,47µF+2x0,01µF+0,68MΩ	GL_, MB_, MGL40, MS_	2441
2	365043	0,27µF+2x0,027µF+1MΩ	MLP	3933

Relais und Schütze

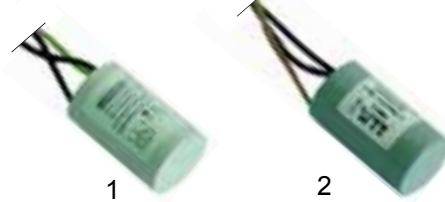

Abb.	Best.-Nr.	Beschreibung	Geräte-Typ	Vergl.-Nr.
1	380307	Relais 20A, 1 Wechsler	MLP60,MLP60E, MLP70, MLP80, MLP140	4105
2	380368	Relais 30A, 1 Schließer	MB235LI, MB240LI, MS350, MS450, MS450E, MS700, MS700E, MLP60, MLP60E, MLP70, MLP80, MLP140	4251
3	380213	Schütz 20A, 4 Schließer	MB510E, MB510ER, MB520, MB520K, MB535, MB530, MB530K, MB630, MB920E, MB920ER, MB930, MB930K, MS_	1857
3	380212	Schütz 20A, 3 Schließer/ 1 Öffner	GL220, GL250, MGL40, MS450, MS450E, MS700, MS700E, MS900, MS1100, MS1300, MLP_	1173

M Thermostate



Abb.	Best.-Nr.	Beschreibung	Geräte-Typ	Vergl.-Nr.
1	390188	Thermostat 30°- 90°C	MB__, MS	4311
2	390442	Sicherheitstherm. 110°C	MB__, MGL40, MS	4309
3	390441	Anlegethermostat 55°C	MB235LI, MB240LI	4277



Abb.	Best.-Nr.	Beschreibung	Geräte-Typ	Vergl.-Nr.
1	390192	Thermostat 0-90°C	GL220, GL250,	1177
2	504021	Knebel	MLP__	1175
3	390194	Sicherheitsthermostat		1887

Elektronik

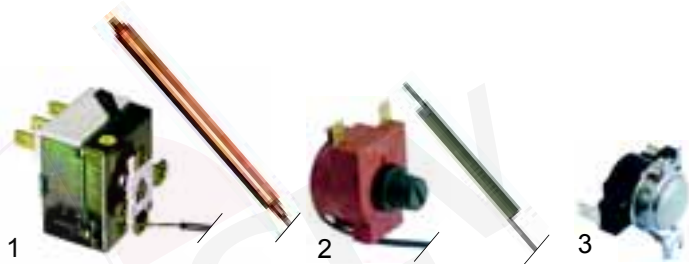

Abb.	Best.-Nr.	Beschreibung	Geräte-Typ	Vergl.-Nr.
1	400717	Elektronik	MGL40	2967
2	504138	Niveausonde	MGL40	2975
3	400714	NTC-Fühler 7x25mm	MGL40	2963
4	504139	Tauchhülse	MGL40	2979



Abb.	Best.-Nr.	Beschreibung	Geräte-Typ	Vergl.-Nr.
1	400713	Thermometer PTC	MGL40, MLP60, MLP70, MLP80, MLP140	2961
2	379052	PTC-Fühler 6x30		2959



Abb.	Best.-Nr.	Beschreibung	Geräte-Typ	Vergl.-Nr.
1	400754	Thermometer NTC	MGL40, MLP60, MLP70, MLP80, MLP140	512063000
2	379161	NTC-Fühler 6x30		512063100



Abb.	Best.-Nr.	Beschreibung	Geräte-Typ	Vergl.-Nr.
1	400716	Elektronik	MS450, MS700, MS900, MS1100	1793
2	400718	Kabel		1797
3	400715	Anzeige Platine		1795
4	400712	Folientastatur	MS1300	1799



Abb.	Best.-Nr.	Beschreibung	Geräte-Typ	Vergl.-Nr.
1	400710	Zeitsteuerung	MLP60, MLP70, MLP80, MLP140	3939
2	400711	Tastatur		3941

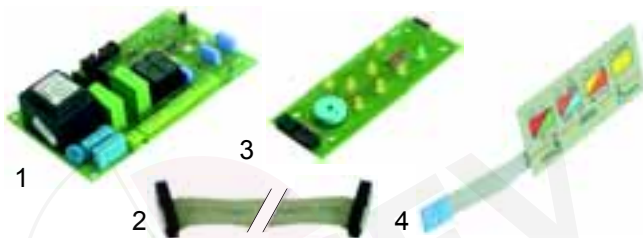

Abb.	Best.-Nr.	Beschreibung	Geräte-Typ	Vergl.-Nr.
1	541086	Thermometer	MS900, MS1100, MS1300, MLP60E	1409
2	550232	Klemmleiste	GL_/MB_/MG140, MS350, MS450, MS450E, MS700, MS700E, MS1100	1181 2847
3	550239	Klemmleiste	MLP__	3931



Abb.	Best.-Nr.	Beschreibung	Geräte-Typ	Vergl.-Nr.
1	504214	Sicherungsklemme	MGL40	2981
2	358690	Feinsicherung 1A(VPE10)	MGL40	2983
2	358697	Feinsicherung 6A(VPE10)	MGL40	2985

Dosiertechnik

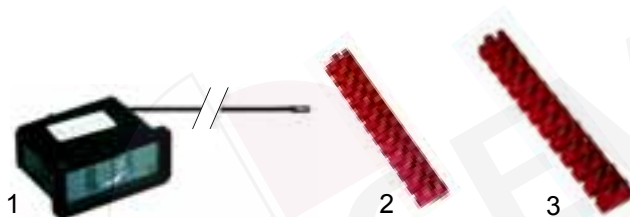

Abb.	Best.-Nr.	Beschreibung	Geräte-Typ	Vergl.-Nr.
1	361009	Nachspülmittel-Dosiergerät		1839
2	361013	Nachspülmittel-Dosiergerät	GL220, GL250, 1965 MGL40, MS__	
3	361218	Nachspülmittel-Dosiergerät	MB__	4285



Abb.	Best.-Nr.	Beschreibung	Geräte-Typ	Vergl.-Nr.
1	361215	Reiniger, Dosiergerät mit Regelung	MG240, MLP60, MLP70, MLP80	2955 4021
2	361156	Reiniger, Dosiergerät mit Regelung	MLP160	4167



Abb.	Best.-Nr.	Beschreibung	Geräte-Typ	Vergl.-Nr.
1	361250	Nachspülmittel-Dosiergerät	MLP60E	4233
2	361015	Nachspülmittel	MLP55/80	2787
3	361014	Reiniger-Dosiergerät		4219



Abb.	Best.-Nr.	Beschreibung	Geräte-Typ	Vergl.-Nr.
1	504125	Wanneneinlauf CNS		2819
2	504082	Boileranschluss		2195

Heizkörper



Abb.	Best.-Nr.	Beschreibung	Geräte-Typ	Vergl.-Nr.
1	416203	2600W/230V	GL__/MB__	1951
2	416205	3000W/230V	GL__/ MB__, MS350, MS450, MS450E, MS70 0E, MGL40	1953
3	416204	2600W/230V-400V	MS450, MS700, MS900, MS1100	1977
4	510408	Dichtung	MGL40	



Abb.	Best.-Nr.	Beschreib.	Geräte-Typ	Vergl.-Nr.
1	416201	2700W/230V	MB235LI, MB240LI	4269
2	416202	2600W/230V	MGL40	2957

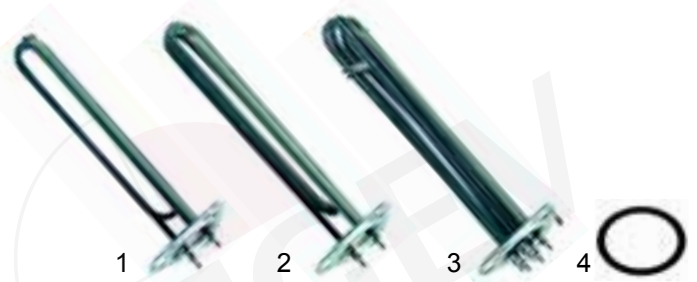

Abb.	B.-Nr.	Beschreib.	Geräte-Typ	Vergl.-Nr.
1	416206	4500W/ 230V-400V	MS450, MS450E, MS700, MS900, MS1100, MS1300	1979
2	416207	6000W/ 230V-400V	MS450, MS450E, MS700, MS700E, MS900, MS1100, MS1300, MLP60, MLP60E, MLP140	1981
3	416208	9000W/ 230V-400V	MS900, MS1100, MS1300, MLP70, MLP80, MLP140	1983
4	510408	Dichtung		

M Boiler

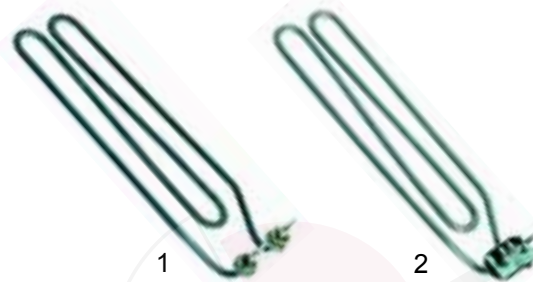

Abb.	Best.-Nr.	Beschreibung	Geräte-Typ	Vergl.-Nr.
1	504067	Boiler (max. 3kW)	GL220, MB520, MB520K, MB530, MB530K, MB535	1935
2	504087	Boiler (max. 3kW)	GL250, MB630, MB930, MB930K	2235
3	504115	Boiler (max. 3kW)	MB235LI, MB510E, MB510ER	2505



Abb.	Best.-Nr.	Beschreibung	Geräte-Typ	Vergl.-Nr.
1	504105	Boiler (max. 3kW)	MB240LI, MB920E, MB920ER	2419
2	504137	Boiler (max. 3kW)	MGL40	2953
3	504094	Boiler (max. 3kW)	MS350	2329



Abb.	B.-Nr.	Beschreibung	Geräte-Typ	Vergl.-Nr.
1	504016	Boiler (max. 6kW)	MS450, MS450E, MS700, MS700E	1101
2	504091	Boiler (max. 9kW)	MS900, MS1100	2259
3	504078	Endkappe, M20x1,5		2023
4	504081	Dichtung		2189
5	504007	Überwurfmutter, 12mm		1069
6	101248	Doppelkonus, 12mm		1071
7	504050	Mutter, M20x1,5		1647
8	504081	Dichtung		2189



Abb.	Best.-Nr.	Beschreibung	Geräte-Typ	Vergl.-Nr.
1	504034	Boiler (max. 9kW)	MS1300	1385
2	504148	Boiler (max. 6kW)	MLP60, MLP60E	3837

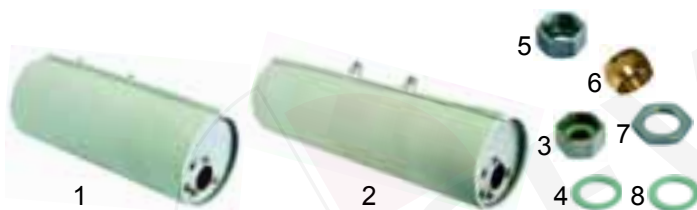

Abb.	Best.-Nr.	Beschreibung	Geräte-Typ	Vergl.-Nr.
1	504158	Boiler (max. 9kW)	MLP70, MLP80	3897
2	504195	Boiler (max. 2x6kW)	MLP140	4257

Pumpen



Abb.	Best.-Nr.	Beschreibung	Geräte-Typ	Vergl.-Nr.
1	500039	Laugenpumpe	MB__PS	2817
2	500332	Drucksteigerungs-pumpe	MLP60, MLP60E,	4459
3	500333	Drucksteigerungs-pumpe	MLP70, MLP80, MLP140	4015



Abb.	Best.-Nr.	Pumpen-Typ	Leistung/ Spannung	Geräte-Typ	Vgl.-Nr.
1	500329	ZF115SX	0,16kW/230V	MB235LI, MB240LI	4317
2	500327	FIR0287	0,33PS/230V	GL220, MB510E, MB510ER, MB520, MB520K, MB530, MB530K, MB535, MB920E, MB920ER	1511
3	500331	ZF160	0,37kW	MB630, MB930, MB930K, MGL40, GL250	2261, 2865



Abb.	Best.-Nr.	Pumpen-Typ	Leistung/ Spannung	Geräte-Typ	Vergl.-Nr.
1	500328	ZF320V	0,65kW/230V	MS350	2309
2	500326	FIR3311	0,75PS/230V	MS350	1201
3	500325	FIR1293	0,75PS/230V	MS450, MS450E	1297, 2119



Abb.	Best.-Nr.	Pumpen-Typ	Leistung/ Spannung	Geräte-Typ	Ver.-Nr.
1	500029	FIR1295	1,2PS/400V	MS700E, MS900	1685, 2139
1	500330	FIR1295	1,2PS/230V	MS900	4225
2	500155	FIR1225	1,5PS/230V	MS1100	4223
2	500023	FIR1225	1,5PS/400V	MS1100	2409
3	500119	FIR1241	1,5PS/230V	MS1300	4221
3	500111	FIR1241	1,5PS/400V	MS1300	1423



Abb.	Best.-Nr.	Pumpen-Typ	Leistung/ Spannung	Geräte-Typ	Ver.-Nr.
1	500323	FIR1227	2,7PS/400V	MLP60, MLP60E	4255
2	500324	FIR1243	3,2PS/400V	MLP70, MLP80, MLP140	4023

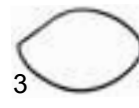

Pumpe		1 Laufrad		2 Gleitringdichtung		3 Gehäusedichtung		4 Pumpendeckel		5 Kondensator	
B.-Nr.	V.-Nr.	B.-Nr.	V.-Nr.	B.-Nr.	V.-Nr.	B.-Nr.	V.-Nr.	B.-Nr.	V.-Nr.	B.-Nr.	V.-Nr.
500327	1511	511210	2159	510695	1523	521701	2157	521501	1529	365015	
500331	2261	521232	2265	510703	1523	521707	2157	521527	1529	365014	
500326	1201	510610	1287	510692	1285	521702	1289	521504	1291	365014	
500328	2309	521246	2315	510702	2321	521714	2313	521539	2311	365014	
500325	1297	510601	1307	510693	1305	510551	1309	521517	1311	365014	
500029	1685	510520	1697	510693	1305	510551	1309	521517	1311	-	-
500330	4225	510520	1697	510693	1305	510551	1309	521517	1311	365014	
500155	2409	510602	2859	510693	1305	510551	1309	510502	2855	365016	
500023	4223	510602	2859	510693	1305	510551	1309	521513	2855	-	-
500111	1423	510357	1441	510693	1305	510551	1309	510531	1437	-	-
500119	4221	510612	1441	510693	1305	510551	1309	510531	1437	365016	
500323	4255	510599	4669	510693	4671	510551	4667	510502	4665	-	-
500324	4023	510357	4113	510693	4115	510551	4111	510531	4109	-	-
500329	4317	521221		510693		521704		521520		365017	

